

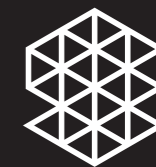

# ameno



The pure elegance.  
A room is a room is a room until Ameno arrives. With impressive technology, multiple functions and endless possibilities, this exclusive planning program gives you a unique aura to your home. Maximum pleasure from an elegant design: this is sophisticated living.

Made in Germany.

# Ameno System

## Ameno

Ameno is a system furniture for individual living room combinations from lowboard and wall units. The optional aluminum backbone gives Ameno special stability and outstanding cable management.

The 4 mm glass or Fenix® surface is mounted on the supporting cabinet. This allows for a high variety of surfaces and colours.

With its high flexibility and sensible options, Ameno can fulfill many individual wishes and integrate almost all technical components. The possibilities are virtually unlimited.

Like all Spectral furniture, Ameno is manufactured in Pleidelsheim in southern Germany.

## Design

Characteristic are the clean lines and the handleless design. The fine, 4 mm edge characterizes the lightness and elegance of Ameno.

## System & grid

The system consists of a grid. First, the box elements are selected according to their dimensions and combined with each other. Then the box elements are equipped with the desired function. Planning or price calculation is only possible with furnplan software.

**Width grid:** 31,5 cm, 63 cm, 94,5 cm, 126 cm, 157,5 cm, 189 cm

**Height grid:** 21 cm, 31,5 cm, 42 cm, 63 cm, 84 cm, 105 cm, 126 cm, 147 cm

**Depth grid:** 38,4 cm, 52,5 cm

## Tailor-made options

Made to measure on request.

## Cabinet

Solid construction with 19 mm wall thickness and 8 mm back wall, doweled and glued, for maximum stability. The cabinet surface Sand is black fine-textured, exceptionally robust and easy to clean. The optional aluminum backbone is pressed to the cabinet.

## Shelves

Height-adjustable glass shelves made from 6 mm safety glass are included from front height of 42 cm. Additional shelves can be ordered for flap compartments and door elements from height of 31,5 cm.

## Top plates

Top plates and side panels must be planned to the cabinets. If there are several elements, a continuous top plate can be selected. Depending on the surface, there are different maximum widths. colour glass, metallic glass and design glass up to 350 cm. Fenix® up to 300 cm.

## Mechanics & function

Handleless push-to-open mechanism. Cup hinges, drawer mechanics with soft closing and flap dampers of the highest quality.

## Installation types

**Standard:** Base pedestal plate, wall mounting, Edge foot or Stick foot are included in the basic price.

**Foot frames:** Bridge and Blade are optionally selectable at additional cost.

Base colour for foot frames and Edge feet is black. Base colour for Stick feet is black and brushed aluminum.

All feet and foot frames can optionally be painted in desired colour.

## Room divider

Ameno can also be placed freely in the room. In this case, the front surface is also mounted on the back. The rear side is then fully clad in the same surface.

## TV integration

TVs can be elegantly integrated with the rotating TV mount. The cable is routed invisibly in the column. There are two TV adapters to choose from: VESA adapter (for TV with VESA standard up to 400 x 400 mm) and Universal TV adapter, with which any TV can be mounted. Alternatively, TVs with feet can be placed on the top plate, the cable routing can be done with a cable opening in the cabinet. With a TV wall mount from Spectral, the TV can also be mounted on the wall, in this case, an on-site cable routing in the wall is recommended.

## Sound integration

Ameno offers two variants for sound integration. In both variants, the flap is covered with acoustic fabric, which allows the sound to escape unhindered.

**Soundbar integration.** Soundbar or subwoofer can be placed behind the fabric flap. **Spectral sound system integration.** Behind the fabric flap there is a receptacle for the Spectral loudspeaker systems and other technical components.

## Lighting

Indirect LED lighting on the rear edge of the furniture. The LED strips can be individually planned at the top, bottom and sides. The LED lighting is dimmable and can be operated by remote control or app. The light colour is warm white (3200 Kelvin).

## Wireless Charging

All current smartphones with Qi standard can be charged wirelessly with Smart Charge. The charging element is invisibly integrated under the surface. A discreet marking shows the area on which charging is possible.

## Cable management

Cables can be routed through the optional spine or through cable openings in the side, top, bottom and rear panels.

## Surfaces

**Colour glass.** Colour glass consists of a 4 mm safety glass plate. The paint finish is applied to the underside. The glass surface is very hard, scratch resistant and easy to clean. There are 5 base colours to choose from as well as over 2,000 custom colours. This can be selected from the NCS or Sikkens 5051 colour chart (most RAL colours are available on request). The glass surface can be selected in gloss or satin (matt).

**Metallic glass.** Metallic glass has the same properties as colour glass and is available in 6 chic metallic colours. The glass surface can be selected gloss or satin (matt).

**Design glass.** Design glass consists of a 4 mm safety glass plate. A high-resolution digital print is applied to the underside. The surface is brilliant and visually indistinguishable from a natural motif. Design glass is very hard, scratch resistant and easy to clean. Design glass is only 4 mm thin and therefore appears light and elegant. The glass surface can be chosen glossy or satin (matt). Satinized glass renders the motif blurred, but thus appears discreet and restrained.

**Design glass is only available for top plates.**

**Fenix®.** Fenix® is an extremely matt nanotech material, the surface is particularly regal and has a velvety touch. It is also resistant to fingerprints. We process Fenix® in the elegant 4 mm thickness. This allows for a particularly light and intricate design. Fenix® is available in 6 harmonious colours.

**Acoustic fabric flaps.** Flaps can also be selected with acoustic fabric.

## Price groups

**Planning or price calculation is only possible with the planning software furnplan at your dealer.**

The surfaces are divided into two price groups.

**Price group 1:** Colour glass and metallic glass

**Price group 2:** Design glass and Fenix®

# Ameno System

The concept: Ameno is a comprehensive and future-proof entertainment furniture program with numerous functional levels. This is how you proceed with the planning:

01

First, select the empty cabinet elements with matching side panels and top plates.

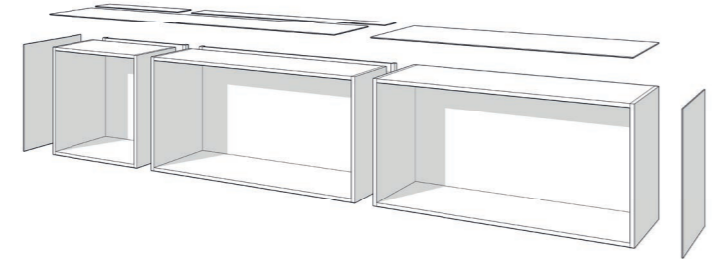

02

Then place the different functional areas, that will later determine the interior.

The media functions are complemented from the classic storage functions.

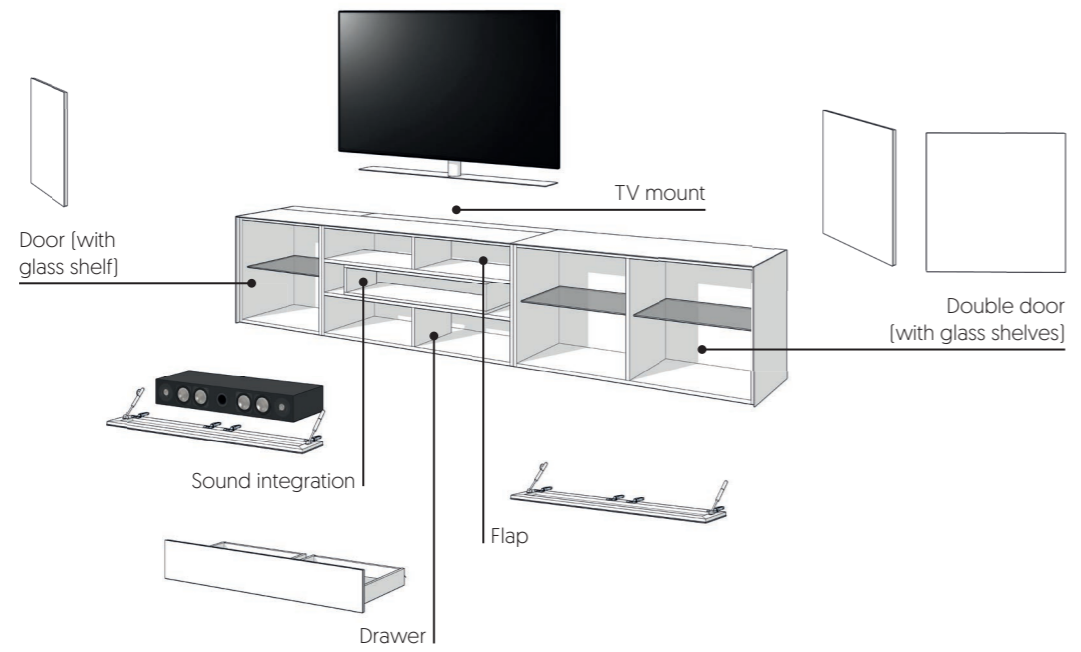

03

This creates a finished piece of furniture from several elements with different functions.

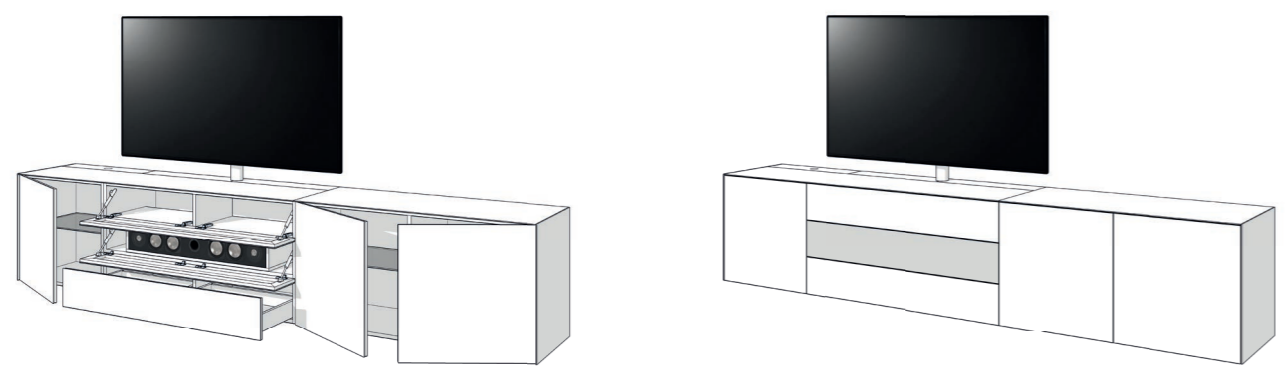

# 1.1 Cabinet elements

Cabinet without backbone

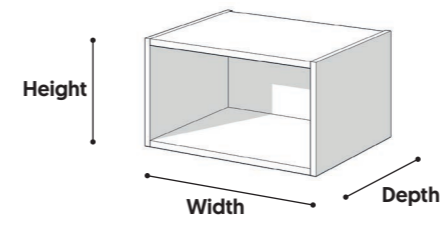

Cabinet with backbone

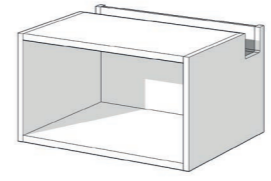

A backbone is required for:

- T70 TV mount
- Power strip

Internal dimension backbone:  
Depth 10,1cm, Height 7,4cm

	Depth 38,4 cm	Depth 52,5 cm
Backbone (cable management)	•	•
Smart Charge	•	•
TV mount	•	•
Power strip	•	•
Partition panel	•	•
Additional glass shelves	•	•
Cable opening	•	•
Subwoofer opening	•	•
Smart Light	•	•

Cabinet elements are available in the following dimensions:

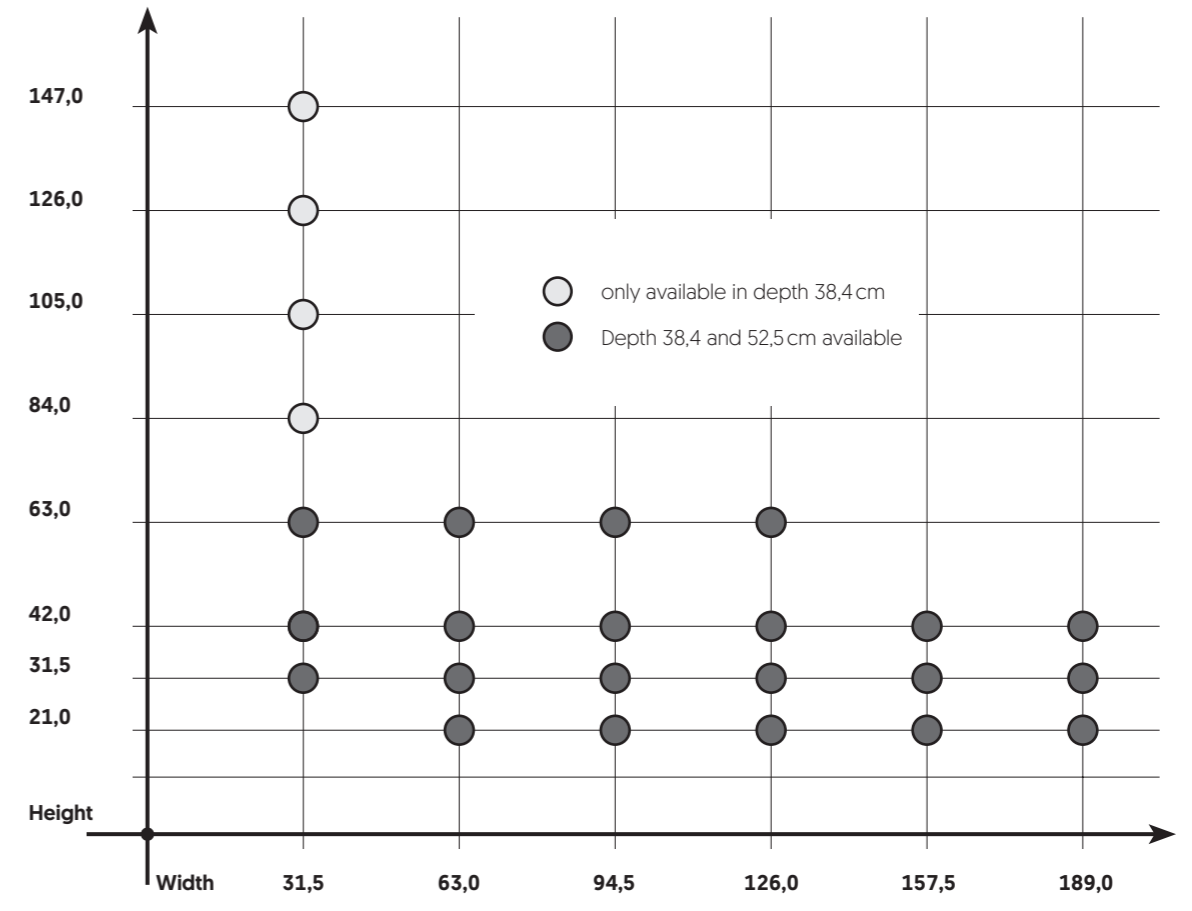

Elements with depth 38,4 cm must be fixed to the wall (fixing material is supplied)

Ameno is only available from selected specialist dealers. Your dealer will provide you with 3D planning and a price quote.

# 1.2 Doors

Door hinge optionally left or right.  
Doors are available in the following finishes:  
Colour glass, metallic glass and Fenix®.  
From height 42 cm, height-adjustable glass shelves included.

**Options** and accessories see section 4 and 5.

**Width:** Plus side panels:  
Glass and Fenix®: 0,6 cm each per side

**Overall height:** Outer dimension plus top plate:  
Glass and Fenix®: 0,6 cm, plus height installation type [see section 3]

### Options and accessories at a glance

	Depth 38,4	Depth 52,5
Additional glass shelves	•	•
Cable opening	•	•
Smart Charge	•	•
Subwoofer opening	•	•
Partition panel	•	•
Smart Light	•	•

# 1.3 Flaps

Flaps are available in the following finishes:  
Colour glass, metallic glass, Fenix® and acoustic fabric.  
Height 42 cm includes height-adjustable glass shelves.  
Flap opening upwards possible up to width 157,5 cm



**Options** and accessories see section 4 and 5.

**Width:** Plus side panels:  
Glass and Fenix®: 0,6 cm each per side

**Overall height:** Outer dimension plus top plate:  
Glass and Fenix®: 0,6 cm, plus height installation type [see section 3]

### Options and accessories at a glance

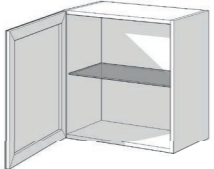
	Depth 38,4	Depth 52,5
Additional glass shelves	•	•
Cable opening	•	•
Smart Charge	•	•
Subwoofer opening	•	•
Partition panel	•	•
Smart Light	•	•

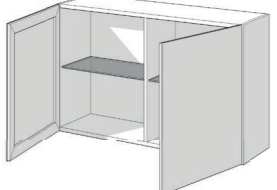
Width	Image	External dimensions (cm)			Internal dimensions (cm)		
		Width	Height	Depth	Width	Height	Depth
<b>31,5 cm</b>		31,5	31,5	38,4 / 52,5	27,7	27,7	33,0 / 47,0
		31,5	42,0	38,4 / 52,5	27,7	38,2	33,0 / 47,0
		31,5	63,0	38,4 / 52,5	27,7	59,2	33,0 / 47,0
		31,5	84,0	38,4	27,7	80,2	33,0
		31,5	105,0	38,4	27,7	101,2	33,0
		31,5	126,0	38,4	27,7	2x 60,1	33,0
		31,5	147,0	38,4	27,7	2x 70,6	33,0
<b>63,0 cm</b>		63,0	63,0	38,4 / 52,5	59,2	59,2	33,0 / 47,0
<b>94,5 cm</b>		94,5	63,0	38,4 / 52,5	2x 44,4	59,2	33,0 / 47,0
<b>126,0 cm</b>		126,0	63,0	38,4 / 52,5	2x 60,1	59,2	33,0 / 47,0

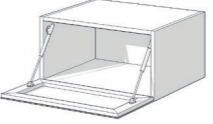
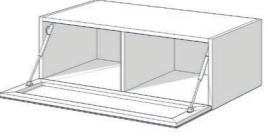
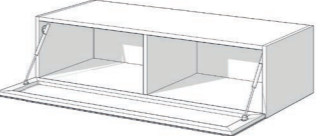
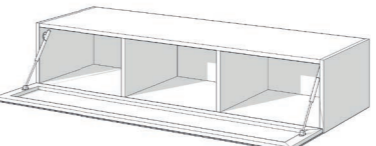
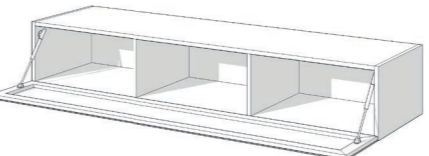
Width	Image	External dimensions (cm)			Internal dimensions (cm)		
		Width	Height	Depth	Width	Height	Depth
<b>63,0 cm</b>		63,0	21,0	38,4 / 52,5	59,2	17,2	33,0 / 47,0
		63,0	31,5	38,4 / 52,5	59,2	27,7	33,0 / 47,0
		63,0	42,0	38,4 / 52,5	59,2	38,2	33,0 / 47,0
<b>94,5 cm</b>		94,5	21,0	38,4 / 52,5	2x 44,4	17,2	33,0 / 47,0
		94,5	31,5	38,4 / 52,5	2x 44,4	27,7	33,0 / 47,0
		94,5	42,0	38,4 / 52,5	2x 44,4	38,2	33,0 / 47,0
<b>126,0 cm</b>		126,0	21,0	38,4 / 52,5	2x 60,1	17,2	33,0 / 47,0
		126,0	31,5	38,4 / 52,5	2x 60,1	27,7	33,0 / 47,0
		126,0	42,0	38,4 / 52,5	2x 60,1	38,2	33,0 / 47,0
<b>157,5 cm</b>		157,5	21,0	38,4 / 52,5	3x 49,9	17,2	33,0 / 47,0
		157,5	31,5	38,4 / 52,5	3x 49,9	27,7	33,0 / 47,0
		157,5	42,0	38,4 / 52,5	3x 49,9	38,2	33,0 / 47,0
<b>189,0 cm</b>		189,0	21,0	38,4 / 52,5	3x 60,4	17,2	33,0 / 47,0
		189,0	31,5	38,4 / 52,5	3x 60,4	27,7	33,0 / 47,0
		189,0	42,0	38,4 / 52,5	3x 60,4	38,2	33,0 / 47,0

# 1.4 Drawers

Drawers are available in the following finishes:  
Colour glass, metallic glass and Fenix®.

**Options** and accessories see section 4 and 5.



Elements with drawer or pull-out shelf must be fixed to the wall (fixing kit is supplied).

**Width:** Plus side panels:  
Glass and Fenix®: 0,6 cm each per side

**Overall height:** Outer dimension plus top plate:  
Glass and Fenix®: 0,6 cm, plus height type of installation [see section 3]

### Options and accessories at a glance

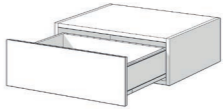
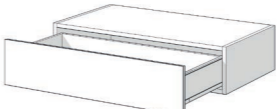
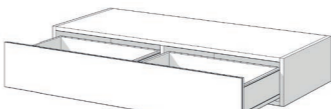
	Depth 38,4	Depth 52,5
Cable opening	•	•
Drawer interior arrangement	•	•
Smart Charge	•	•
Partition panel		•
Smart Light	•	•

Width	Image	External dimensions [cm]			Internal dimensions [cm]		
		Width	Height	Depth	Width	Height	Depth
<b>63,0 cm</b>		63,0	10,5	38,4 / 52,5	55,0	4,6	27,4 / 37,4
		63,0	21,0	38,4 / 52,5	55,0	13,2	27,4 / 37,4
		63,0	31,5	38,4 / 52,5	55,0	23,7	27,4 / 37,4
		63,0	42,0	38,4 / 52,5	55,0	34,2	27,4 / 37,4
<b>94,5 cm</b>		94,5	10,5	38,4 / 52,5	86,5	3,9	27,4 / 37,4
		94,5	21,0	38,4 / 52,5	86,5	10,7	27,4 / 37,4
		94,5	31,5	38,4 / 52,5	86,5	21,2	27,4 / 37,4
		94,5	42,0	38,4 / 52,5	86,5	31,7	27,4 / 37,4
<b>126,0 cm</b>		126,0	10,5	38,4 / 52,5	2x 55,9	4,6	27,4 / 37,4
		126,0	21,0	38,4 / 52,5	2x 55,9	13,2	27,4 / 37,4
		126,0	31,5	38,4 / 52,5	2x 55,9	23,7	27,4 / 37,4
		126,0	42,0	38,4 / 52,5	2x 55,9	34,2	27,4 / 37,4
<b>157,5 cm</b>		157,5	10,5	38,4 / 52,5	2x 71,7	3,9	27,4 / 37,4
		157,5	21,0	38,4 / 52,5	2x 71,7	10,7	27,4 / 37,4
		157,5	31,5	38,4 / 52,5	2x 71,7	21,2	27,4 / 37,4
		157,5	42,0	38,4 / 52,5	2x 71,7	31,7	27,4 / 37,4

# 1.5 Soundbar integration

Fabric flap including height-adjustable universal storage tray to accommodate of soundbar systems from various manufacturers.

Options and accessories see section 4 and 5.

**Width:** Plus side panels:  
Glass and Fenix®: 0,6 cm each per side

**Overall height:** Outer dimension plus top plate:

Glass and Fenix®: 0,6 cm, plus height type of installation (see section 3)

### Options and accessories at a glance

	Depth 38,4	Depth 52,5
Cable opening	•	•
Smart Charge	•	•
Subwoofer opening	•	•
Partition panel		•
Smart Light	•	•

# 1.5 Soundbar integration

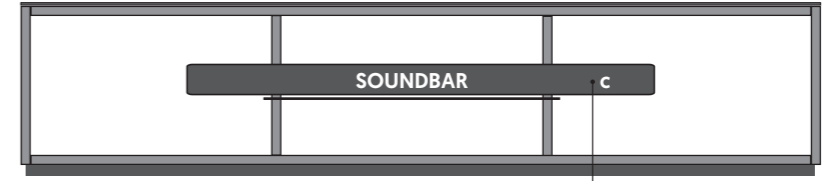

max. dimension soundbar

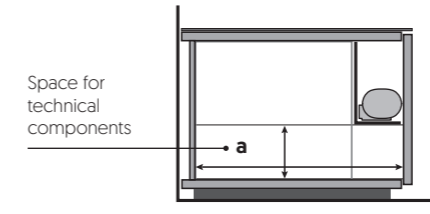

Space for technical components

a = max. dimension below soundbar

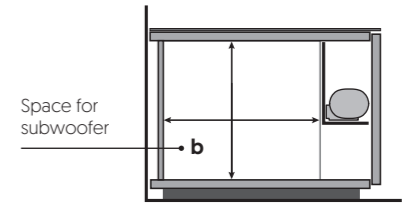

Space for subwoofer

b = Dimension behind the soundbar

Width	Image	External dimensions (cm)			Internal dimensions (cm)			
		Width	Height	Depth	Width	Height	Depth	
94,5 cm		94,5	21,0	38,4 / 52,5	<b>a</b>	44,4	3,5	33,0 / 47,0
					<b>b</b>	44,4	17,2	20,6 / 34,6
					<b>c</b>	84,5	13,5	11,6
		94,5	31,5	38,4 / 52,5	<b>a</b>	44,4	14,0	33,0 / 47,0
					<b>b</b>	44,4	27,7	20,6 / 34,6
					<b>c</b>	84,5	20,5	11,6
		94,5	42,0	38,4 / 52,5	<b>a</b>	44,4	24,5	33,0 / 47,0
					<b>b</b>	44,4	38,2	20,6 / 34,6
					<b>c</b>	84,5	20,5	11,6
126,0 cm		126,0	21,0	38,4 / 52,5	<b>a</b>	60,1	3,5	33,0 / 47,0
					<b>b</b>	60,1	17,2	20,6 / 34,6
					<b>c</b>	116,0	13,5	11,6
		126,0	31,5	38,4 / 52,5	<b>a</b>	60,1	14,0	33,0 / 47,0
					<b>b</b>	60,1	27,7	20,6 / 34,6
					<b>c</b>	116,0	20,5	11,6
		126,0	42,0	38,4 / 52,5	<b>a</b>	60,1	24,5	33,0 / 47,0
					<b>b</b>	60,1	38,2	20,6 / 34,6
					<b>c</b>	116,0	20,5	11,6

Width	Image	External dimensions (cm)			Internal dimensions (cm)			
		Width	Height	Depth	Width	Height	Depth	
157,5 cm		157,5	21,0	38,4 / 52,5	<b>a</b>	49,9	3,5	33,0 / 47,0
					<b>b</b>	49,9	17,2	20,6 / 34,6
					<b>c</b>	147,5	13,5	11,6
		157,5	31,5	38,4 / 52,5	<b>a</b>	49,9	14,0	33,0 / 47,0
					<b>b</b>	49,9	27,7	20,6 / 34,6
					<b>c</b>	147,5	20,5	11,6
		157,5	42,0	38,4 / 52,5	<b>a</b>	49,9	24,5	33,0 / 47,0
					<b>b</b>	49,9	38,2	20,6 / 34,6
					<b>c</b>	147,5	20,5	11,6
189,0 cm		189,0	21,0	38,4 / 52,5	<b>a</b>	60,4	3,5	33,0 / 47,0
					<b>b</b>	60,4	17,2	20,6 / 34,6
					<b>c</b>	179,0	13,5	11,6
		189,0	31,5	38,4 / 52,5	<b>a</b>	60,4	14,0	33,0 / 47,0
					<b>b</b>	60,4	27,7	20,6 / 34,6
					<b>c</b>	179,0	20,5	11,6
		189,0	42,0	38,4 / 52,5	<b>a</b>	60,4	24,5	33,0 / 47,0
					<b>b</b>	60,4	38,2	20,6 / 34,6
					<b>c</b>	179,0	20,5	11,6

Ameno is only available from selected specialist dealers. Your dealer will provide you with 3D planning and a price quote.

Ameno is only available from selected specialist dealers. Your dealer will provide you with 3D planning and a price quote.

# 1.6 Spectral sound system integration

Fabric flap including mounting for the Spectral sound system SCA3 or BRA3 or the Spectral loudspeaker BRP1.  
 Only available in combination with a Spectral sound system or a Spectral loudspeaker.  
 An amplifier is required for the BRP1 passive speaker.  
 We recommend using a Sonos Amp.  
 For prices and technical data on sound systems and speakers, see sound systems chapter.

Options and accessories see section 4 and 5.

**Width:** Plus side panels:  
 Glass and Fenix®: 0,6 cm each per side  
**Overall height:** Outer dimension plus top plate:  
 Glass and Fenix®: 0,6 cm, plus height type of installation [see section 3]

**Options and accessories at a glance**

	Depth 38,4	Depth 52,5
Cable opening	•	•
Smart Charge	•	•
Partition panel		•
Smart Light	•	•

Height	Image	External dimensions (cm)			Internal dimensions (cm)		
		Width	Height	Depth	Width	Height	Depth

<b>21,0 cm</b>		94,5	21,0	38,4 / 52,5	a	-	-	-
		126,0	21,0	38,4 / 52,5	a	14,5	17,2	33,0 / 47,0
		157,5	21,0	38,4 / 52,5	a	30,2	17,2	33,0 / 47,0
		189,0	21,0	38,4 / 52,5	a	45,8	17,2	33,0 / 47,0

Sound level with fabric flap

Matching Spectral sound systems: SCA3 / BRA3 / BRP1

<b>31,5 cm</b>		126,0	31,5	38,4 / 52,5	a	60,1	9,9	33,0 / 47,0
					b	13,8	15,9	33,0 / 47,0

Sound cabinet with fabric flap

Matching Spectral sound systems: SCA3 / BRA3 / BRP1

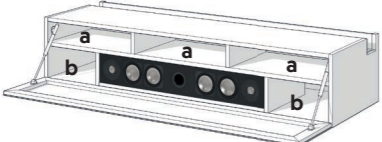
	157,5	31,5	38,4 / 52,5	a	49,9	9,9	33,0 / 47,0
				b	29,5	15,9	33,0 / 47,0
	189,0	31,5	38,4 / 52,5	a	60,4	9,9	33,0 / 47,0
				b	45,4	15,9	33,0 / 47,0

Sound cabinet with fabric flap

Matching Spectral sound systems: SCA3 / BRA3 / BRP1

# 1.6 Spectral sound system integration

Fabric flap including mounting for the Spectral sound system VRA3 or the Spectral VRP1 loudspeaker.  
 Only available in conjunction with a Spectral sound system or a Spectral loudspeaker.  
 An amplifier is required for the VRP1 passive speaker.  
 We recommend using a Sonos Amp.  
 For prices and technical data on sound systems and speakers, see chapter sound systems.

Options and accessories see section 4 and 5.

**Width:** Plus side panels:  
 Glass and Fenix®: 0,6 cm each per side  
**Overall height:** Outer dimension plus top plate:  
 Glass and Fenix®: 0,6 cm, plus height type of installation [see section 3]

**Options and accessories at a glance**

	Depth 52,5
Cable opening	•
Smart Charge	•
Partition panel	•
Smart Light	•

Height	Image	External dimensions (cm)			Internal dimensions (cm)		
		Width	Height	Depth	Width	Height	Depth

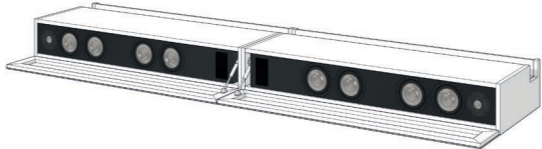
<b>21,0 cm</b>		2x	126,0	21,0	52,5	2x	122,2	17,2	47,0
		Matching Spectral sound systems: VRA3 / VRP1							

2x Sound level with fabric flap

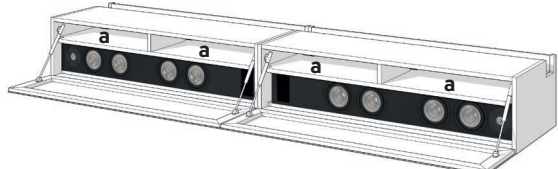
<b>31,5 cm</b>		2x	126,0	31,5	52,5	a	60,1	6,9	47,0
						b	-	-	-

Matching Spectral sound systems: VRA3 / VRP1

2x Sound cabinet with fabric flap

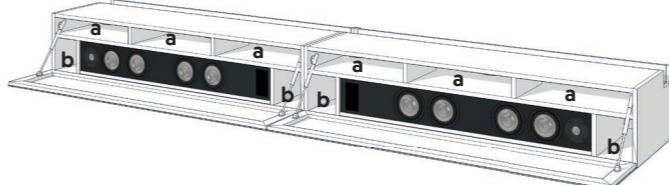
	2x	157,5	31,5	52,5	a	49,9	6,9	47,0
					b	13,8	18,8	47,0
	2x	189,0	31,5	52,5	a	60,4	6,9	47,0
					b	29,6	18,8	47,0

2x Sound cabinet with fabric flap

Matching Spectral sound systems: VRA3 / VRP1

# 1.7 Open wall units

The wall thickness is 1,2 cm. Intermediate shelves and bars are firmly glued. Additional shelves are not possible. The wall mounting kit is included. Rear wall colour can be selected independently of the cabinet colour.

Open wall units are not available in black.

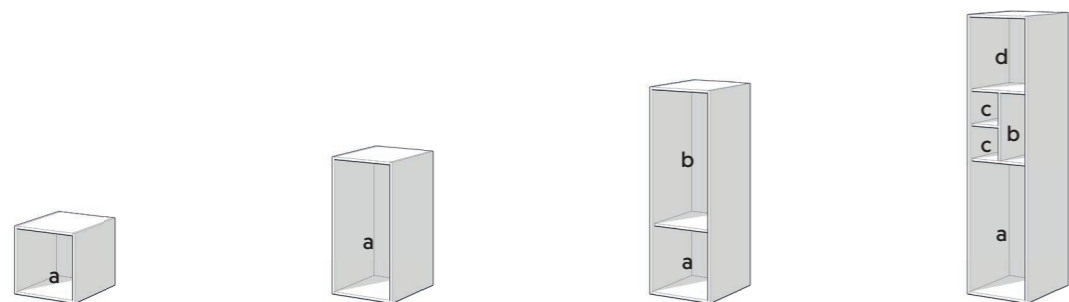

AM-031-031-038-B003

AM-031-063-038-B003

AM-031-094-038-B003

AM-031-126-038-B003

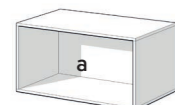

AM-063-031-038-B003

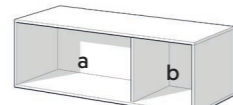

AM-094-031-038-B003

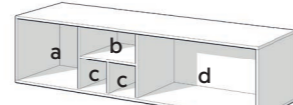

AM-126-031-038-B003

Article	External dimensions (cm)			Internal dimensions (cm)		
	Width	Height	Depth	Width	Height	Depth
AM-031-031-038-B003	31,5	31,5	38,4	a	29,1	29,1 34,8
AM-031-063-038-B003	31,5	63,0	38,4	a	29,1	60,6 34,8
AM-031-094-038-B003	31,5	94,5	38,4	a	29,1	30,0 34,8
				b	29,1	60,9 32,8
AM-031-126-038-B003	31,5	126,0	38,4	a	29,1	60,9 34,8
				b	13,9	30,3 32,8
				c	13,9	14,5 32,8
				d	29,1	30,3 32,8
AM-063-031-038-B003	63,0	31,5	38,4	a	60,6	29,1 34,8
AM-094-031-038-B003	94,5	31,5	38,4	a	60,9	29,1 34,8
				b	30,0	29,1 34,8
AM-126-031-038-B003	126,0	31,5	38,4	a	30,0	29,1 34,8
				b	30,3	13,9 32,8
				c	14,5	13,9 34,8
				d	60,9	29,1 34,8

Ameno is only available from selected specialist dealers. Your dealer will provide you with 3D planning and a price quote.

# 1.8 Glass-fronted elements

The wall thickness is 1,2 cm. The door is made of clear glass, door swing optionally left or right. Shelves are not possible. The wall mounting is included. Rear wall colour can be selected independently of the cabinet colour.

Display cases are not available in black colour.



AM-031-031-038-B004

AM-031-063-038-B004

Article	External dimensions (cm)			Internal dimensions (cm)		
	Width	Height	Depth	Width	Height	Depth
AM-031-031-038-B004	31,5	31,5	38,4	a	29,1	29,1 33,8
AM-031-063-038-B004	31,5	63,0	38,4	a	29,1	60,6 33,8

Ameno is only available from selected specialist dealers. Your dealer will provide you with 3D planning and a price quote.



# 1.9 Top plates and side panels

**Top plates** are available in the colour glass, metallic glass, design glass and Fenix® surfaces. Depending on the surface, there are different maximum widths: Colour glass, metallic glass, design glass up to 350.0 cm, Fenix® up to 300.0 cm. For design glass over several top plates, image processing is not possible.

**Side panels** are available in the colour glass, metallic glass and Fenix® surfaces.

## Standard top plate

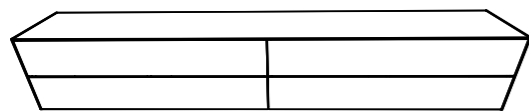

Cabinet with total depth of 38,4 cm. Top plate comprises a single, seamless element.

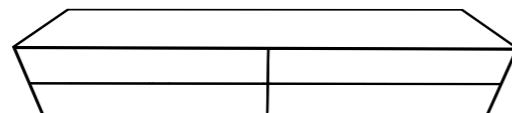

Cabinet with total depth of 52,5 cm. Top plate comprises a single, seamless element.

## Top plate with backbone

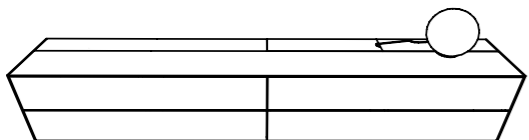

Cabinet with total depth of 38,4 cm. Front of top plate comprises an element with a depth of 24,3 cm. Rear of top plate comprises a total of three elements with a depth of 14,0 cm.

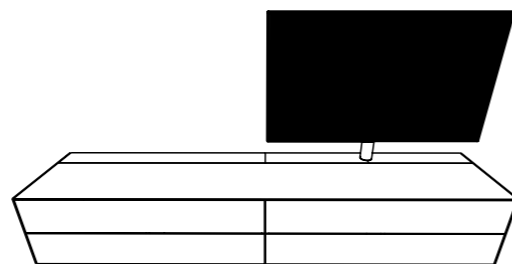

Cabinet with total depth of 52,5 cm. Front of top plate comprises an element with a depth of 38,4 cm. Right-hand rear of top plate comprises two elements with a depth of 14,0 cm for TV mount. Left-hand rear of top plate comprises a single element with a depth of 14,0 cm.

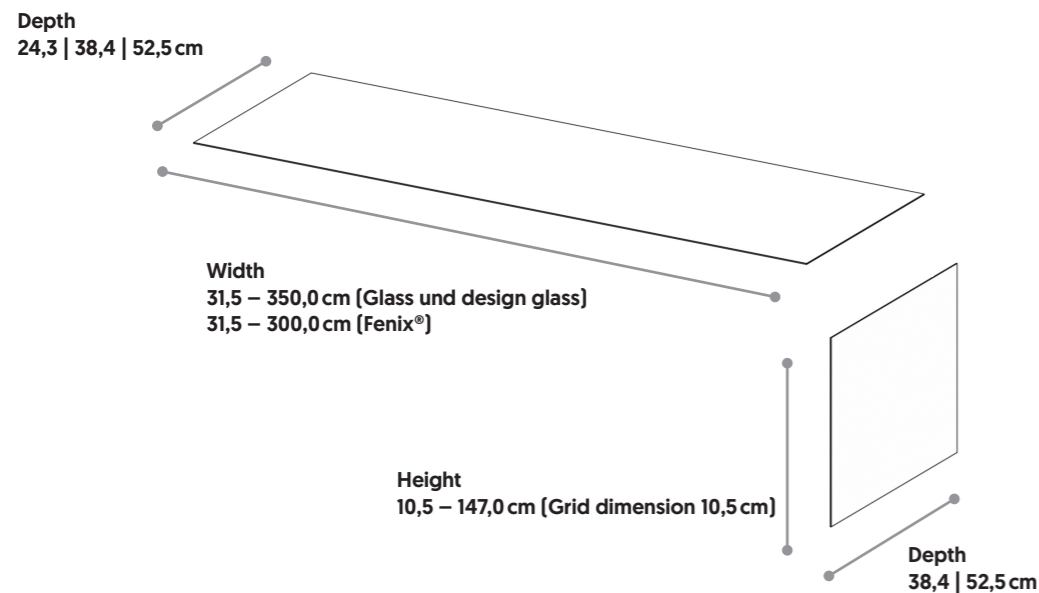

Ameno is only available from selected specialist dealers. Your dealer will provide you with 3D planning and a price quote.

# 1.10 Top plates for backbones and trim panels

**Top plates for backbones** with depth 14,0 cm are available in colour glass, metallic glass, design glass and Fenix® surfaces. Image processing is not possible with design glass over several top plates. Fenix® can be planned from a width of 31,5 cm.

**Trim panels** for the underside are available for elements with depth 38,4 cm in colour glass, metallic glass and Fenix® surfaces.

Image	Top plates for backbones	Width (cm)									
		15,7	31,5	47,2	63,0	78,7	94,5	126,0	157,5	189,0	
	Standard (without opening)		•	•	•	•	•	•			
	T70L For TV mount (opening Ø 7 cm)	•	•	•	•	•	•	•			
	T70R For TV mount (opening Ø 7 cm)	•	•	•	•	•	•	•			
	WLC For Smart Charge (WLC)				•						
	CG-L With cable opening (opening Ø 2 cm)		•	•	•	•	•	•			
	CG-R With cable opening (opening Ø 2 cm)		•	•	•	•	•	•			

Image	Trim panels for the underside of elements	Width (cm)									
		15,7	31,5	47,2	63,0	78,7	94,5	126,0	157,5	189,0	
	For elements with a depth of 38,4 cm		•		•		•	•	•	•	

Ameno is only available from selected specialist dealers. Your dealer will provide you with 3D planning and a price quote.

# 2. Tailor-made options





With Ameno you have options for customization. Tailor-made according to your ideas, custom carpentry for your home. Popular changes are in the table below.

For more options and information, please visit our website at [www.spectral.eu/tailor-made](http://www.spectral.eu/tailor-made) or inquire directly with our customer service department by email at [info@spectral.eu](mailto:info@spectral.eu).

Type of change	Remarks
Dimension change * [1 charge for all dimension changes per combination]	Modifications only in 10,5 grid, also adjustments of the fronts only in this grid
Special glass	For example: cable outlet at rear edge glass top plate
Change interior layout S	Small change, e.g. shorten center bar
Change interior layout L	Major change, such as customization or division
Alter position of the TV-mount	
Modification TV-column	Change height, add drill holes etc.
Add steel reinforcement	From clear width 67,0 cm
Cable outlet / cutout in the wooden cabinet D = 6,0cm, position according to sketch	Price per additional cutout or omission of a cutout
Cable outlet / cutout in the wooden cabinet individual according to sketch	Price per cutout
Reposition wall mount bracket	

### 3.1 Installation types standard

The base colour is black matt (Stick is also possible in the surface polished aluminum). Stick and Edge feet can be optionally painted in desired colour according to NCS or Sikkens 5051 colour chart.

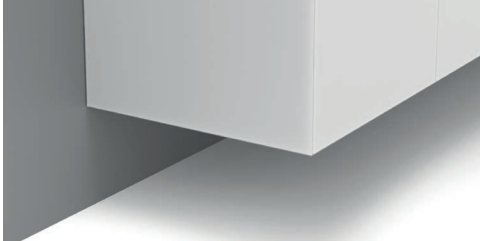
Image	Type	Dimensions (cm)
		Height
	Base	2,2 – 3,2
	Stick	7,8 – 8,8
	Edge	13,0 – 13,5
Image	Type	Dimensions (cm)
		Height
	Wall mounted	optional

### 3.2 Installation types foot frames

The base colour is black matt, all base frames can optionally be painted in desired colour according to NCS or Sikkens 5051 colour guide. The crossbars between the frame parts are always black.

All foot frames are height adjustable:  
 Blade: Height 16,0 cm + 0,5 cm  
 Bridge: Height 18,5 cm + 1,0 cm

Image	Function	Dimensions (cm)		Dimensions foot frames		
		Depth	Width	Width	Height	Depth
	Blade with 2 frame parts	38,0	126,0 – 189,0	101,8 – 181,8	16,0	33,6
		48,0	126,0 – 189,0	101,8 – 181,8	16,0	43,6
	Blade with 3 frame parts	38,0	220,5 – 346,5	202,8 – 322,8	16,0	33,6
		48,0	220,5 – 346,5	202,8 – 322,8	16,0	43,6
	Bridge with 2 frame parts	38,0	126,0 – 189,0	101,8 – 181,8	18,5	29,8
		48,0	126,0 – 189,0	101,8 – 181,8	18,5	39,8
	Bridge with 3 frame parts	38,0	220,5 – 346,5	201,8 – 321,8	18,5	29,8
		48,0	220,5 – 346,5	201,8 – 321,8	18,5	39,8
	Blade					
	Bridge					







# 4. Options and accessories

Image	Article	Function
 <p>VESA 200x200 – 400x400    VESA 100x100 – 400x600</p>	<b>BGH-TX</b>	<b>TV mount TX</b> aluminium or black <b>TV mount TX</b> in colour of your choice Optionally with adapter for VESA 200 x 200 to 400 x 400 or universal adapter for any TV up to VESA 600 x 400 TX mount is not possible in combination with backbone
	<b>SPMEX1</b>	<b>Extension kit VESA 600 x 600</b> for universal adapter
 <p>VESA 200x200 – 400x400    VESA 100x100 – 400x600</p>	<b>BGH-T70</b>	<b>TV mount T70</b> aluminium or black <b>TV mount T70</b> in colour of your choice Optionally with adapter for VESA 200 x 200 to 400 x 400 or universal adapter for any TV up to VESA 600 x 400 A backbone is required for a T70 mount
	<b>SPMEX1</b>	<b>Extension kit VESA 600 x 600</b> for universal adapter
	<b>ZU2093</b>	<b>Universal media mount</b> For any media components, mounting on the rear of the TV mount
	<b>Option</b>	<b>Cable opening</b> in the top plate [CA] Diameter 6,0 cm
	<b>ZU2139</b> <b>ZU2140</b>	<b>Cover for cable opening</b> , white <b>Cover for cable opening</b> , black Cable feed through possible
	<b>Option</b>	<b>Cable opening</b> in the bottom

Ameno is only available from selected specialist dealers. Your dealer will provide you with 3D planning and a price quote.

# 4. Options and accessories

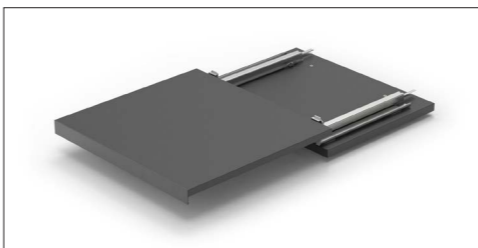
\* Elements with drawer or pull-out shelf and all elements with Depth 38,4 cm must be fixed to the wall (fixing material is supplied).

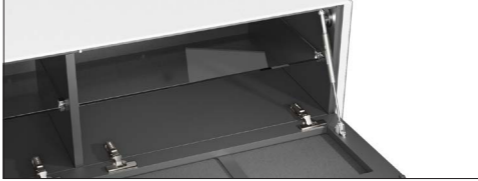
Image	Article	Function
	<b>Option</b>	<b>Subwoofer opening</b> Incl. black fabric cover, position optionally in the middle, left or right compartment. Not possible with type installation Base
	<b>ZU2231</b>	<b>Subwoofer elastic buffer [4 pcs.]</b> For optimal positioning in the furniture
	<b>Option</b>	<b>Fabric flap</b> Covered with acoustic fabric, optionally in the colours black, carbon, pebble, grey, graphite or silver
	<b>Option *</b>	<b>Drawer (SL)</b> instead of flap
	<b>SLE01 *</b>	<b>Insert for interior arrangement for drawer</b>
	<b>TA01 *</b>	<b>Pull-out shelf</b> Dimension of footprint (w x d): 44,0 cm x 41,2 cm, height: 6,4 cm Extendable by 32,0 cm Required compartment depth: min. 43,3 cm Required compartment width: - compartment without flap damper: 45,1 cm - compartment with one flap damper: 47,6 cm - compartment with two flap dampers: 50,1 cm
	<b>Option</b>	<b>Back panels for partitions</b> For floor standing lowboards with flap in depth 52,5 cm. Not possible for elements with drawer or pull-out shelf.
	<b>Option</b>	<b>Additional glass shelf</b> For closed elements with flaps or doors, height adjustable

Ameno is only available from selected specialist dealers. Your dealer will provide you with 3D planning and a price quote.

# 4. Options and accessories

Image	Article	Function
	<b>Option</b>	<b>Backbone (cable channel)</b> Internal dimension: Depth 10,1 cm, Height 7,4 cm
	<b>ZU1841</b>	<b>Power strip</b> for backbone 5-way, incl. 2x USB Charger
	<b>Option</b>	<b>Continuous top plate</b> In case of several elements, a continuous top plate can be selected. Colour glass, metallic glass and design glass up to max. 350,0 cm, Fenix® up to 300,0 cm
	<b>ZU1933</b>	<b>Smart charge kit</b> The Smart Charge wireless charging technology uses the common Qi standard of the Wireless Power Consortium, to which all major mobile device manufacturers adhere to.
	<b>ZU1864</b>	<b>IR link system</b> For control of audio and video equipment when furniture flap is closed
	<b>ZU1871</b>	<b>Flat europlug</b> Flat europlug 1,5 m cable, Schuko connections [not available in the UK]
		<b>Spectral spray</b> A gentle foam cleaner for LED, LCD, plasma and computer screens. Also suitable for glass, metal and painted surfaces. With an anti-static microfiber cloth for swift, streak-free cleaning. Contains 300 ml.

# 5. Smart Light

Image	Article	Function
	<b>LED-AM</b>	<b>Indirect LED lighting</b> Lighting along rear edge of furniture. Depending on the model, the position of the LED strips can be individually planned at the top, sides and bottom. Light colour warm white, approx. 3200 Kelvin
	<b>LED-AN2</b>	<b>Connection kit LED-AN2</b> For operation by remote control or smartphone app with dimming function. For LED strips that are 5 m or longer a second connection set is required.
		<b>Example pricing:</b> The price is based on the furniture dimensions: $42,0\text{ cm} + 126,0\text{ cm} + 42,0\text{ cm} = \mathbf{210,0\text{ cm}}$
		<b>Example pricing:</b> The price is based on the furniture dimensions: $42,0\text{ cm} + 126,0\text{ cm} + 63,0\text{ cm} + 42,0\text{ cm} = \mathbf{273,0\text{ cm}}$
		Smart Light for elements W=31,5cm only possible up to height 126,0 cm
	<b>ZU1873</b>	<b>Interior lighting</b> LED light with motion sensor
	<b>ZU1874</b>	<b>USB charger</b> For interior lighting

# 6. Load

## Elements with plinth, Stick feet, Edge feet

Max. load on top plate (in kg)	Max. load per drawer compartment (in kg)
60	20

## Elements / combinations with foot frame

	Max. total load for each foot frame (in kg)	Max. load on top plate (in kg)
Foot frame for width 126,0 – 220,5 cm	60	60
Foot frame for width 252,0 – 346,5 cm	80	60

## Wall mounted elements (depth 38,4 cm)

Width	Height	Max. total load (in kg) *	Max. load on top plate (in kg)
Width 31,5 – 189,0 cm	Height 21,0 – 31,5 cm	40	40
Width 31,5 – 189,0 cm	Height 42,0 cm	50	40
Width 31,5 cm	Height 63,0 – 147,0 cm	60	40
Width 63,0 – 126,0 cm	Height 63,0 cm	80	40

Width	Height	Max. load for each drawer compartment (in kg)	Max. load for each shelf (in kg)
Width 31,5 – 189,0 cm	Height 21,0 – 31,5 cm	10	–
Width 31,5 – 189,0 cm	Height 42,0 cm	10	–
Width 31,5 cm	Height 63,0 – 147,0 cm	10	30
Width 63,0 – 126,0 cm	Height 63,0 cm	10	30

## Wall mounted elements (depth 52,2 cm)

Width	Height	Max. total load (in kg) *	Max. load on top plate (in kg)
Width 31,5 – 189,0 cm	Height 21,0 – 31,5 cm	40	40
Width 31,5 – 189,0 cm	Height 42,0 cm	60	40
Width 31,5 – 126,0 cm	Height 63,0 cm	75	40

Width	Height	Max. load for each drawer compartment (in kg)	Max. load for each shelf (in kg)
Width 31,5 – 189,0 cm	Height 21,0 – 31,5 cm	10	–
Width 31,5 – 189,0 cm	Height 42,0 cm	10	–
Width 31,5 – 126,0 cm	Height 63,0 cm	10	30

\* Does not include load from TV mount

# 6. Load

## TV mount

	Max. load (in kg)
TX	50
T70	70

### Max. load on TV mount T70 for free-standing elements

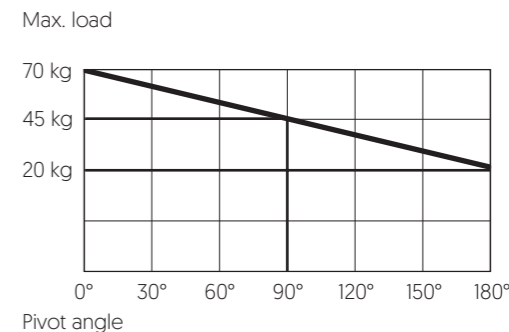
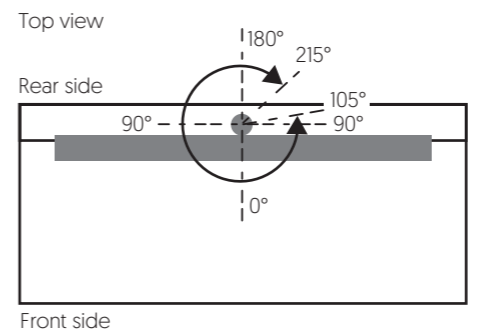

## Glass shelves

	Max. load for each glass shelf (in kg)
Glass shelf	15

## Pull-out shelf

	Max. load for each pull-out shelf (in kg)
TA01	20

## Open elements and glass-fronted elements

	Max. total load (in kg)
Elements with 1 compartment	10
Elements with 2 compartments	20
Elements with 5 compartments	40

### Max. load in and above the compartments

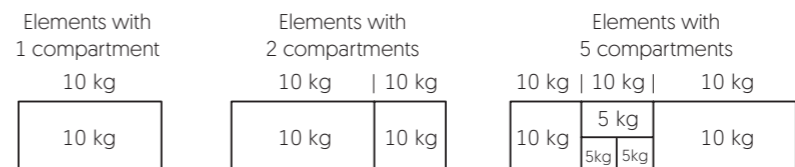

# 7. Ameno colours & surfaces

## Colour glass – glossy or satin

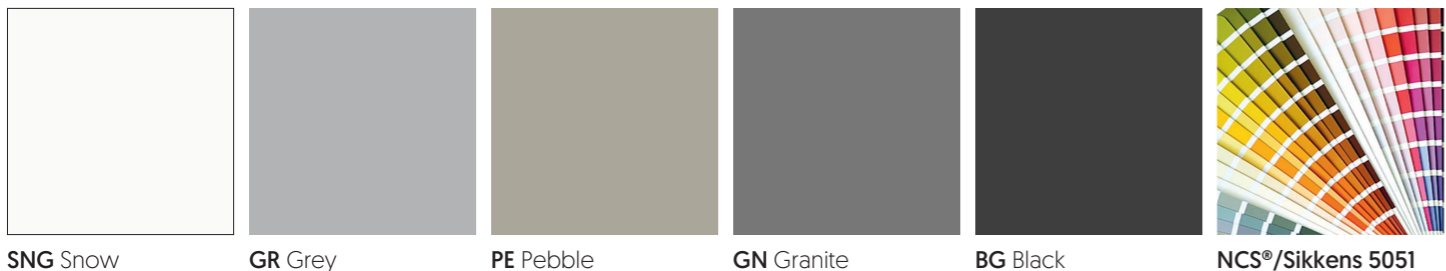

## Metallic glass – glossy or satin



## Fenix® – matt, soft touch & anti fingerprint



## Design glass – glossy or satin

Exclusively available for top plates

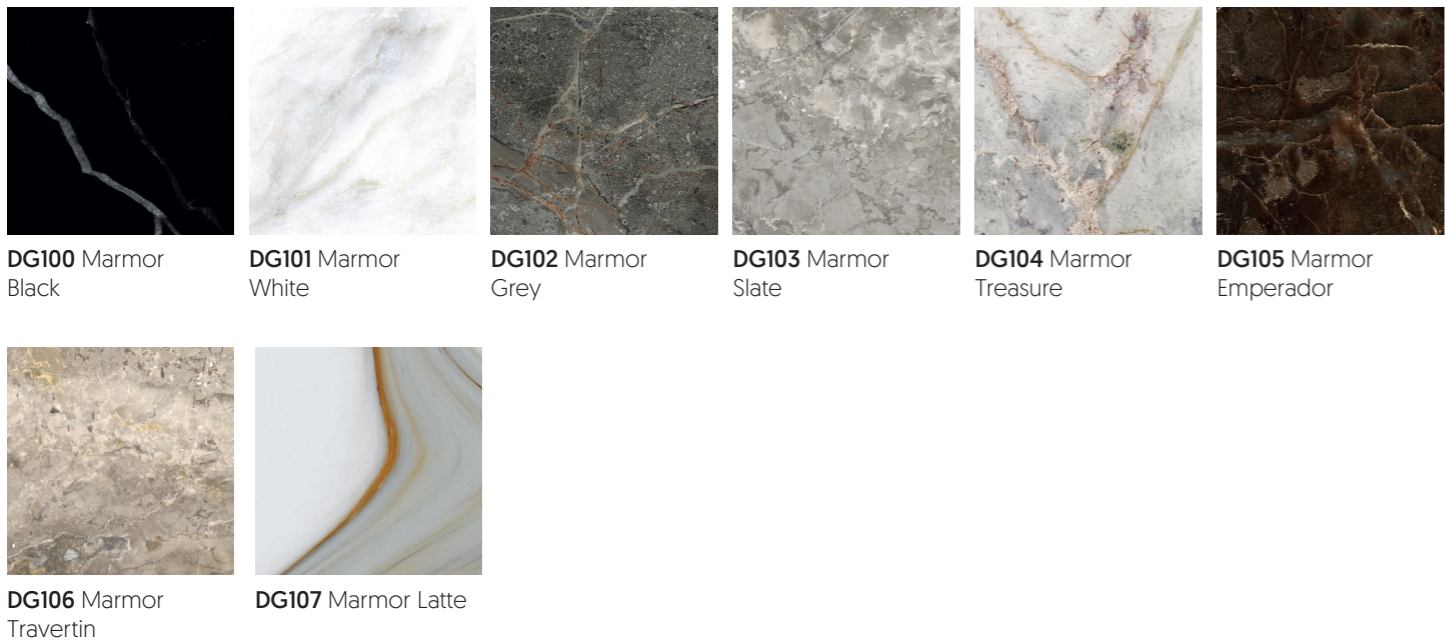

## Acoustic fabric flaps

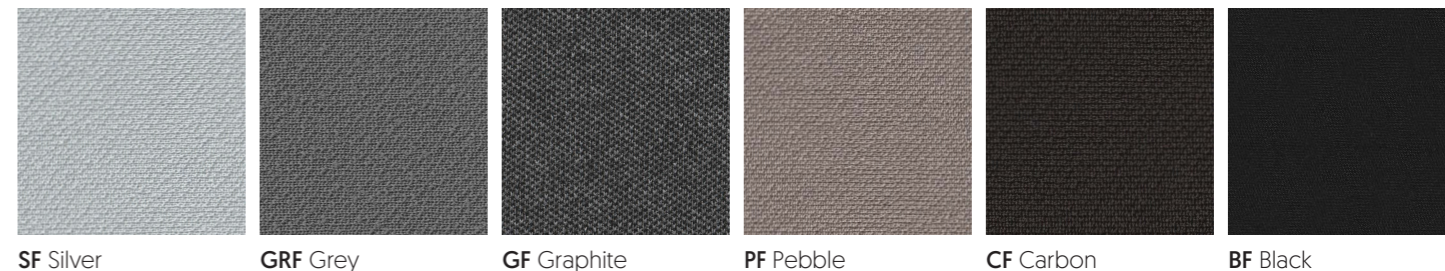

## Metal surfaces

Edge feet, Stick feet, foot frames Bridge and Blade and column TV mount



Base colour  
Edge feet, foot frame Bridge, Blade and Frame  
BG Black

Base colour  
Column TV mount and Stick feet  
BG Black and aluminium

**Note on glass surfaces:**  
Glass is a product made from natural raw materials and is subject to variations in production technology. Depending on the inherent colour of the glass, glass thickness and lighting conditions, there may be colour differences between different glass surfaces.  
Likewise, there may be deviations between glass samples in the specialized trade and the finished furniture. In the case of subsequent deliveries of glass surfaces, production- and batch-dependent colour differences are possible and do not constitute grounds for complaint.

**Note on fabrics:**  
Fabrics are subject to production variations. Therefore, there may be colour differences between different fabric-related components.  
Likewise, there may be deviations between fabric samples in the specialist trade and the finished furniture. In the case of subsequent deliveries of fabric-related components, production- and batch- dependent colour differences are possible and do not constitute grounds for complaint.